



*Destiny Custom Homes*

BUILD YOUR DREAMS WITH US

*Luxury  
Inclusions*

## *Destiny Custom Home's Luxury Inclusions*

*The home building industry is highly competitive, with each builder trying to differentiate themselves by offering unique features and amenities. This has resulted in a proliferation of options, making it difficult for potential homebuyers to choose the right builder.*

*To address this issue, Destiny Custom Homes' is offering "DCH's Luxury Inclusions." This service provides a comprehensive list of high-end features*

*and amenities that are typically only offered as optional add-ons or upgrades by other builders.*

*In addition to this, Destiny Custom Homes has set a high standard with their luxury lists, ensuring that their customers receive only the best, most desirable features in their new DREAM HOMES. This approach has helped Destiny Custom Homes stand out in a crowded market and attract discerning customers who are looking for the very best in homebuilding.*

*Destiny is all...*





# Internal Selections



## External Selections

- Roof.....22
- Bricks.....23-24
- Doors.....25-26
- Gutter & Facia.....27
- Windows.....28
- Paint.....29
- Special Inclusion.....30

## Internal Selections

- Flooring.....05
- Staircase.....06
- Internal Doors.....07
- Door Furniture.....08
- Kitchen.....09-11
- Laundry.....12
- Living.....13-14
- Storage.....15
- Air Conditioner.....16
- Bathroom.....17-19
- Electrical.....20



Flooring is an essential element in any space, providing both functional and aesthetic benefits. It sets the foundation for the overall design and ambience of a room. From hardwood and laminate to tile and carpet, there is a wide range of flooring options available to suit different preferences and needs. Hardwood flooring adds warmth and elegance, while laminate offers durability and affordability. Tile flooring is popular for its versatility and easy maintenance, and the carpet provides comfort and insulation. Choosing the right flooring material requires considering factors like durability, maintenance, style, and budget.

► Your choice of ceramic tiles to entry, hallway, family, kitchen and meals areas. Choice of 50/50 wool blend carpet from builders' range for upstairs and stairs.

Choose ceramic tiles that complement your lifestyle for entry, hallway, family, kitchen, and meal areas in a modern style.

Modern, versatile carpet options for all areas, including staircases, in double-story homes. Choose the perfect carpet to suit your style.

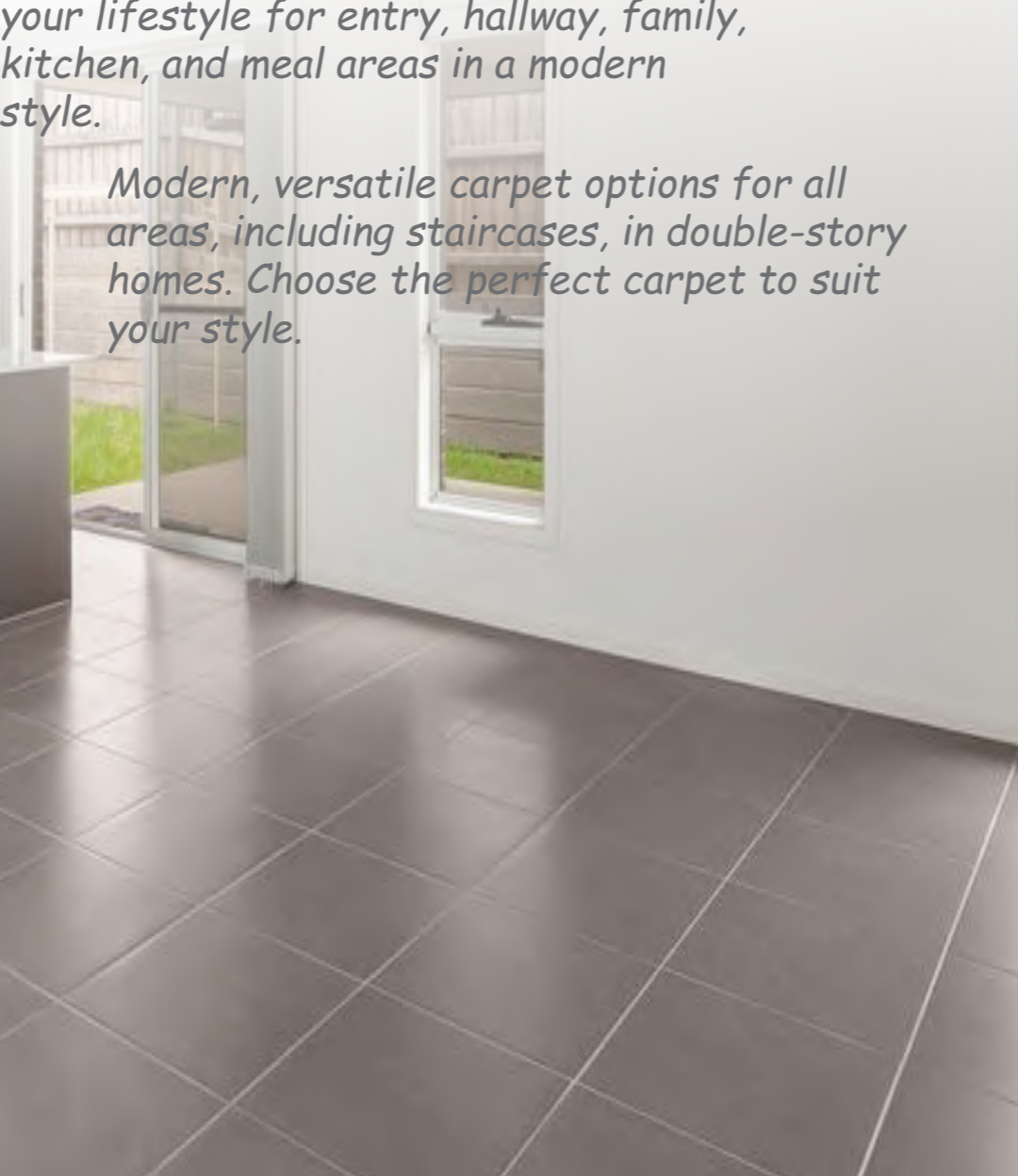

The staircase in the home gracefully ascends, connecting the different levels with elegance. Its sturdy banisters guide your hand as you traverse each step, instilling a sense of security. The polished wooden treads creak ever so slightly, echoing the stories of countless footsteps. Sunlight pours through the nearby window, illuminating the staircase's intricate details. It stands as both a functional pathway and a striking architectural feature, enhancing the beauty and grandeur of the home. Each ascent and descent carry you to new heights, weaving memories within the very fabric of the house.

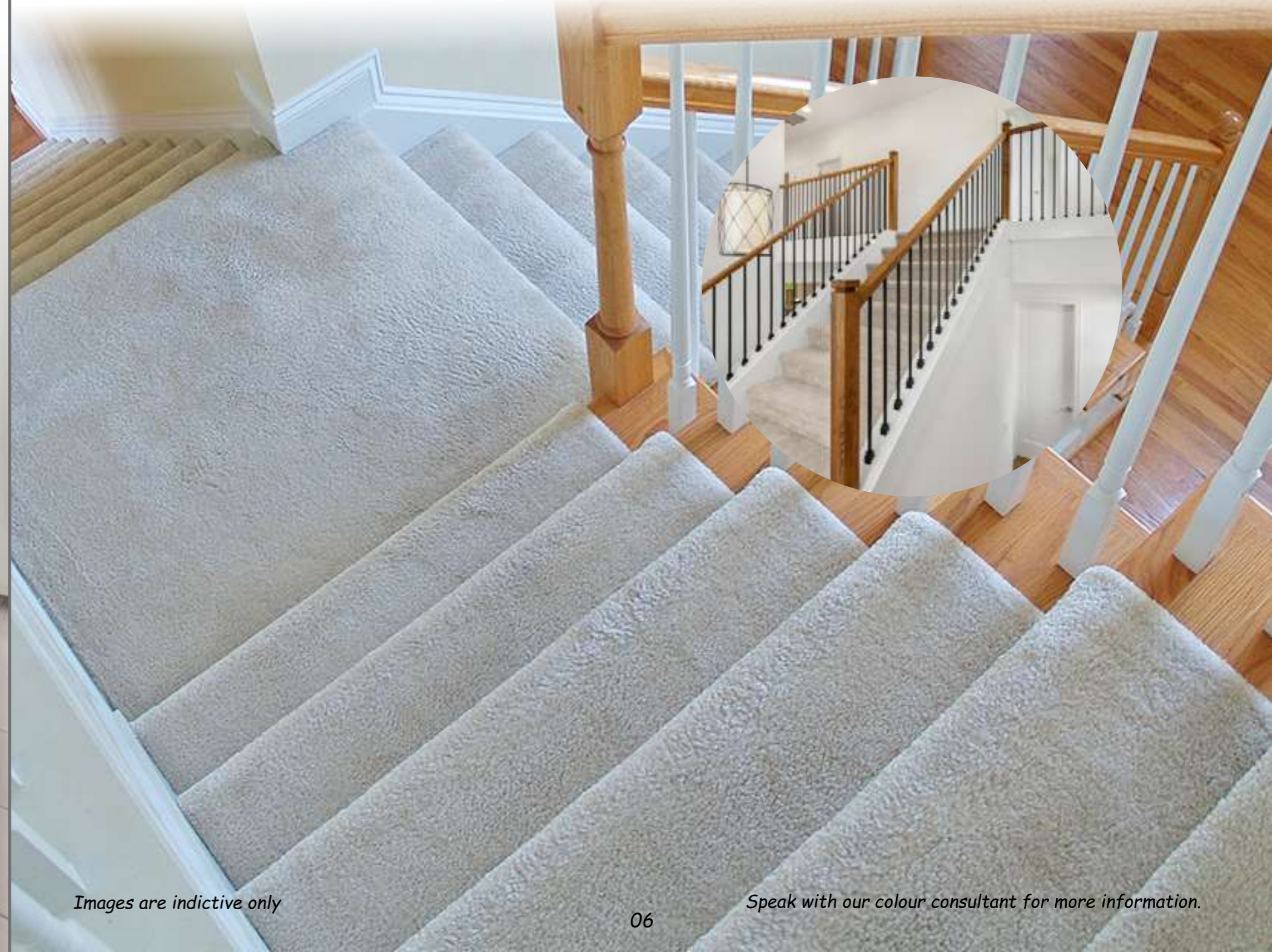

Internal doors in the home serve multiple purposes, combining functionality and aesthetics. They provide privacy, sound insulation, and define separate living spaces within a residence. From traditional wooden doors to modern glass panels, a wide range of styles and materials are available. Sliding doors save space, while French doors add elegance and natural light. Pocket doors offer a seamless transition between rooms. The choice of internal doors can enhance the overall interior design, complementing the decor and creating a harmonious atmosphere throughout the home.



Bright chrome hinges to all internal doors



Door stops throughout  
All internal doors come with door stops.

2040mm High internal designer plain door with smooth paint finish Cushioned door stops to all internal doors

Door's accessories play a significant role in enhancing the functionality and aesthetics of a home. From handles and knobs to hinges and locks, these components ensure smooth operation and security. Doorstops prevent damage to walls and floors, while peepholes provide a sense of safety. Weatherstripping and draft excluders help maintain insulation, reducing energy costs. Decorative elements like door knockers and kick plates add character to entryways. With a wide range of options available, door accessories offer practical and decorative solutions for every home.

Standard range of lever Set with a choice of bright chrome or stain chrome. Privacy locks to all bathrooms, ensuite's & power rooms design specific from the DCH's Range



The kitchen is the heart of any home, where culinary creativity comes to life. It's a space where delicious aromas fill the air and memories are made. From sizzling pans to the comforting warmth of an oven, the kitchen is a hub of activity and nourishment. It's a place where families gather, friends' bond over meals, and recipes are passed down through generations. The kitchen is more than just a room; it's a sanctuary of flavours, laughter, and love.



Images are indicative only

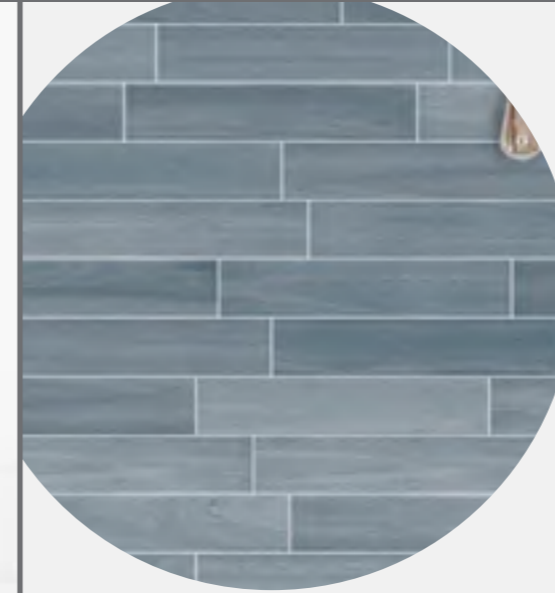

### Plashback

Tiles or window (as per plans) splashback for cooktop from the DCH's range.

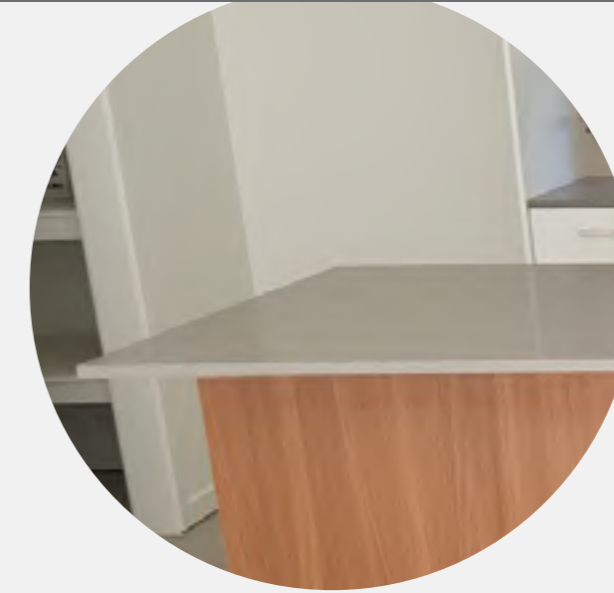

### Benchtop

20mm Engineered Stone bench-top with choice of colour from the Destiny Custom Homes' Range



### Cabinetry

Fully laminated cupboards, drawers and kitchen finishes with door handles from the DCH's range.



### Cupboard Handles

Select from a contemporary and functional handle range available in a Polished Chrome, Stainless steel, Satin Chrome & Matt black finish from the DCH's range.

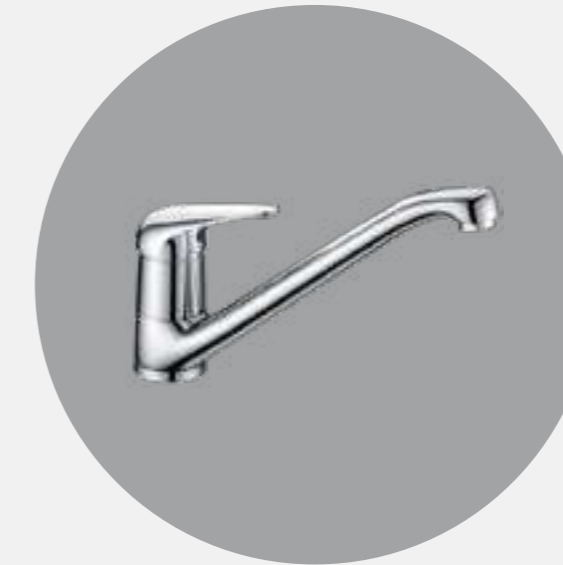

### Tapware

Kitchen sink tap from the DCH's range.



### Sink

Clean line 1 $\frac{3}{4}$  bowl stainless steel sink.

**Kitchen bulkheads:** Painted plasterboard finish over all cupboards to upgrade your kitchen's overall look.

Images are indicative only

## KITCHEN APPLIANCES

### Rangehood



Westinghouse 600mm Canopy Rangehood Stainless

### Dishwasher



Westinghouse 600mm stainless steel dishwasher

### Cooktop



Westinghouse 600mm 4 Zone Ceramic Cooktop with Knob Control

OR

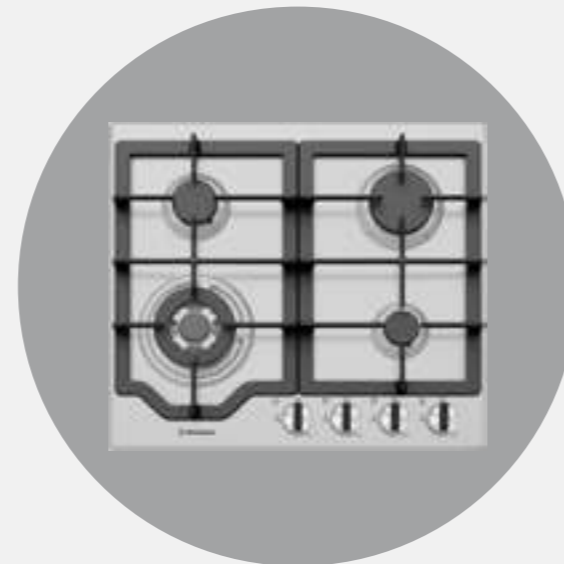

Westinghouse 600mm 4 Burner Stainless Steel Gas Cooktop

Laundry in the home has become an essential part of our daily routines. With the convenience of modern washing machines and dryers, we can easily tackle the never-ending pile of clothes. Sorting whites from colours, measuring detergent, and selecting the right settings have become second nature. The hum of the machines and the fresh scent of clean laundry bring a sense of accomplishment. Folding and organizing clothes neatly adds a touch of order to our lives. It's a chore that connects us with the basic necessity of cleanliness.



### Stainless Steel Tub

42L stainless steel tub with white metal cabinet for all your laundry and household needs.

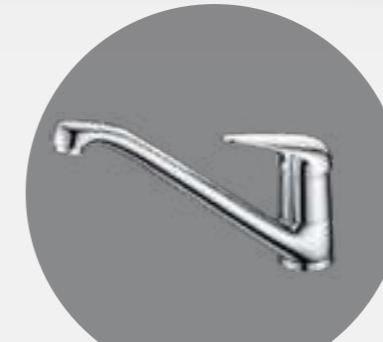

### Sink Mixer

This durable design mixer with easy grip handle style is made to last.

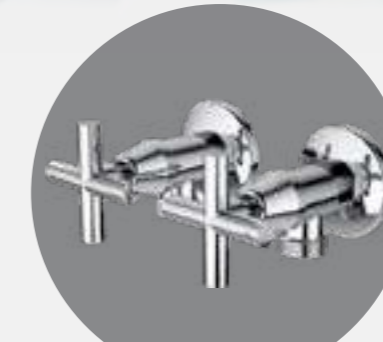

### Washing Machine

High hollow core Hume flush panel with painted finish to linens (match internal doors).



### Splashback

Protect walls with ceramic splashback tiles up to 300mm behind tubs.



### Laundry Floor

Elegant laundry flooring with 300mm high skirting with ceramic tiles.

The living room is the heart of a home, where comfort and style converge. It is a sanctuary for relaxation and socialization, a space designed to reflect the unique personality of its inhabitants. The room boasts plush sofas and chairs, inviting occupants to sink into their soft cushions. Warm lighting casts a gentle glow, creating an ambience of tranquillity. Adorned with tastefully chosen artwork and decorative elements, the walls become a gallery of memories and personal expression. A coffee table serves as a focal point, adorned with books, flowers, and cherished mementos. The living room is a space for laughter, conversation, and cherished moments shared among family and friends.



### Internal Wall

Taubmans' paint to internal walls.

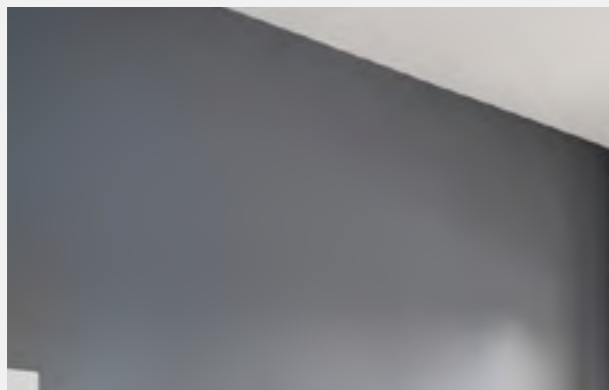

Images are indicative only

### Gas Bayonet



One internal gas bayonet point to the location of your choice (subject to gas mains availability).

Speak with our colour consultant for more information.

### Architraves

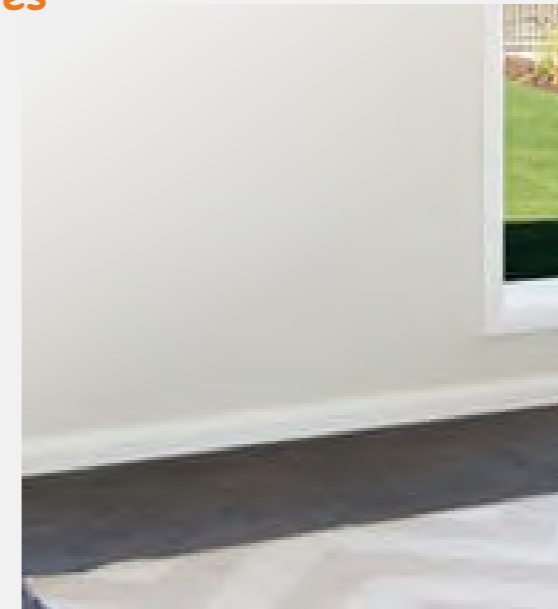

68mm x 18mm pencil round profile architraves with paint finish, where applicable

### Skirtings



Tile skirting with chrome capping (tiles floor area)

Images are indicative only

### Internal Ceiling Heights



Single storey homes feature high ceilings measuring 2440mm, Double storey homes feature high ceilings measuring 2590mm, giving your new home a sense of spaciousness and letting more natural light flow throughout.

### Cornices



90mm cove cornice will be installed, with the exception of the bathrooms.

Speak with our colour consultant for more information.



## Wardrobes



2100mm high aluminium framed mirror sliding doors.

FIND A HOME FOR YOUR CLOTHES  
Tailor your wardrobe for a customised storage solution. Talk to your personal designer to help you create the perfect fit.

## Wardrobe Shelving



Single white melamine shelf with hanging rail to wardrobes and walk-in robes.

STORAGE  
You'll have plenty of room for your bedding, linens and small items.

## Linen Cupboard



High hollow core Hume flush panel with painted finish to linens (match internal doors).

## Linen Shelving



Four white melamine shelves to linen cupboard. Provide easy storage for your all your family linens (designed to standard plans).

Speak with our colour consultant for more information.

Images are indicative only

Air conditioning provides enhanced comfort, improved air quality, increased productivity, better sleep quality, preservation of electronics and furniture, heatstroke prevention, reduced allergens and odours, and increased security. However, energy consumption and environmental impact should be considered, and responsible use and maintenance can help mitigate these concerns.



Samsung ducted Air con installation is based on home plans for a single/double storey home. Supply and install includes all duct to service up to outlets according plans 2 zones, 900 x 500mm return air grill.

Images are indicative only

Speak with our colour consultant for more information.

The bathroom is an essential part of any home, providing a private space for personal hygiene and grooming. It typically contains a sink, toilet, and shower or bathtub, along with storage for toiletries and other essentials. Bathrooms can vary in size and design, from small half-baths to luxurious en-suites with spa-like features. They also serve as a functional space for getting ready in the morning or winding down at night. With the right decor and accessories, bathrooms can be transformed into a relaxing retreat within the home. Overall, a well-designed and well-maintained bathroom can add both value and comfort to a home.



## Shower Screens

Framed shower screens with pivot door, clear laminated glass.

The tiling height in the shower area is set to 1900 mm.



Images are indicative only

## Stylus Toilet

Stylus toilet Close coupled toilet suite with Smartflush technology. The neatly designed suite adds a modern touch from the DCH's range.



Speak with our colour consultant for more information.



## Shower Rail

Shower Features an ergonomic handshower bracket with push button for easy height adjustment from the DCH's range.

## 2-in-1 Unit



2-in-1 combined fan/light/heater unit to bathroom and ensuite from the DCH's range..

## Acrylic Bathtub

A simple and clean white design, with an anti-slip base and dual soap dishes. Also includes a chrome plug and waste from the DCH's range.

(Where suitable, otherwise 1525mm)



- Bathrooms and ensuites with ceramic floor tiles with 300mm high skirting. Separate toilets and powder rooms with 150mm high skirting.

Images are indicative only

## Vanity

Customize your floating vanity with a 20mm stone benchtop and choose your preferred colour and design. Add a stylish and practical touch to your vanity with up to 200mm high ceramic tile splashback from DCH's range.



## Choice Of Sink



Stylus drop-in basin

OR



Stylus semi-recessed basin  
Integral chrome plug with dress ring and waste with overflow at the back of the basin from the DCH's range.

Speak with our colour consultant for more information.

## Wall Mixer



Chrome mixer with an easy grip style is made to last from the DCH's range.

## Bath Spout

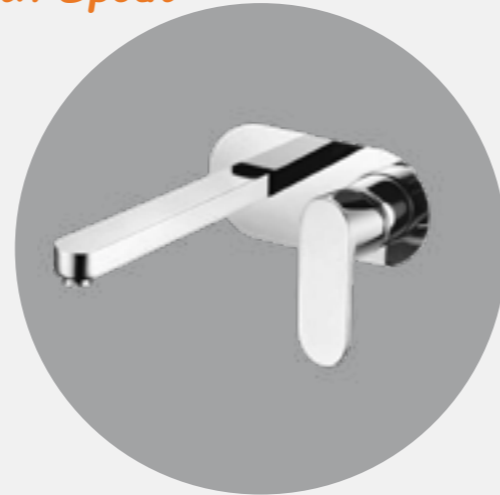

## Basin Mixer



Chrome mixer with an easy grip style is made to last from the DCH's range.

## Towel Rail



A sleek look, & fuss-free towel rail from the DCH's range.

## Vanity mirror



A frameless polished edge mirror.

## Soap Dish



Includes acrylic soap dish and dual fixings for added strength from the DCH's range.

## Toilet Roll Holder



With a modern chrome finish to match your other accessories from the DCH's range.

## Chrome Floor Waste



A smart and simple touch to complete your contemporary bathroom design from the DCH's range.

Electrification in the home has come a long way since the early days of electricity. Today, we rely heavily on electricity to power our homes, from lighting to heating and cooling, cooking, cleaning, and entertainment. The availability of affordable and efficient home appliances and devices has made our lives easier, but it has also increased our energy consumption. To address this, many households are adopting energy-efficient technologies such as LED lighting, smart thermostats, and solar panels. These technologies not only help reduce our energy bills but also contribute to a cleaner and more sustainable future by reducing our carbon footprint.



Clipsal 2 Gang 10amp Switch



Clipsal TV PAL Antenna Socket Plate

- Single phase underground mains provision for connection to meter.
- One Single power point for fridge.
- One Single power point for range-hood.
- One Isolation switch for oven.
- Batten holder to all light points.
- Two way switch to stairs. (Double storey dwelling only).
- One Exhaust fan to WC (design specific).
- Security alarm Including LED Panel
- 1 Phone point, 1 NBN Point and 2 TV Points
- Hard wired smoke detectors with battery back-up as required One External light point to eaves at external doors.
- Automatic electric circuit breakers, all earth leakage safety switches at power board. Hard wired smoke detectors with battery back-up as required.



Clipsal Double Power Point



Clipsal Batten Holder 2pin Bayonet

## NBN PROVISION

- Underground conduit provision and draw wire from front boundary to under meter box.
- NBN approved conduit provision and draw wire from under meter box to internal wall of garage.
- One Double power point to internal wall of garage.
- One Phone point and Cat6 data point on One plate to wall of garage.



Weatherproof Double GPO

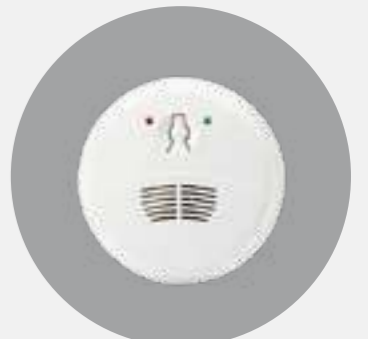

Clipsal Flush Recessed Mount Smoke Alarm

## External Selections



### Elabana Concrete Roof

Concrete tiles offer colour longevity and flexibility, with a diverse array of shades and profiles available. By applying a straightforward re-coating, you can easily refresh your roof's appearance. Moreover, you can opt for colour technologies that preserve your home's allure and enhance its resale value.

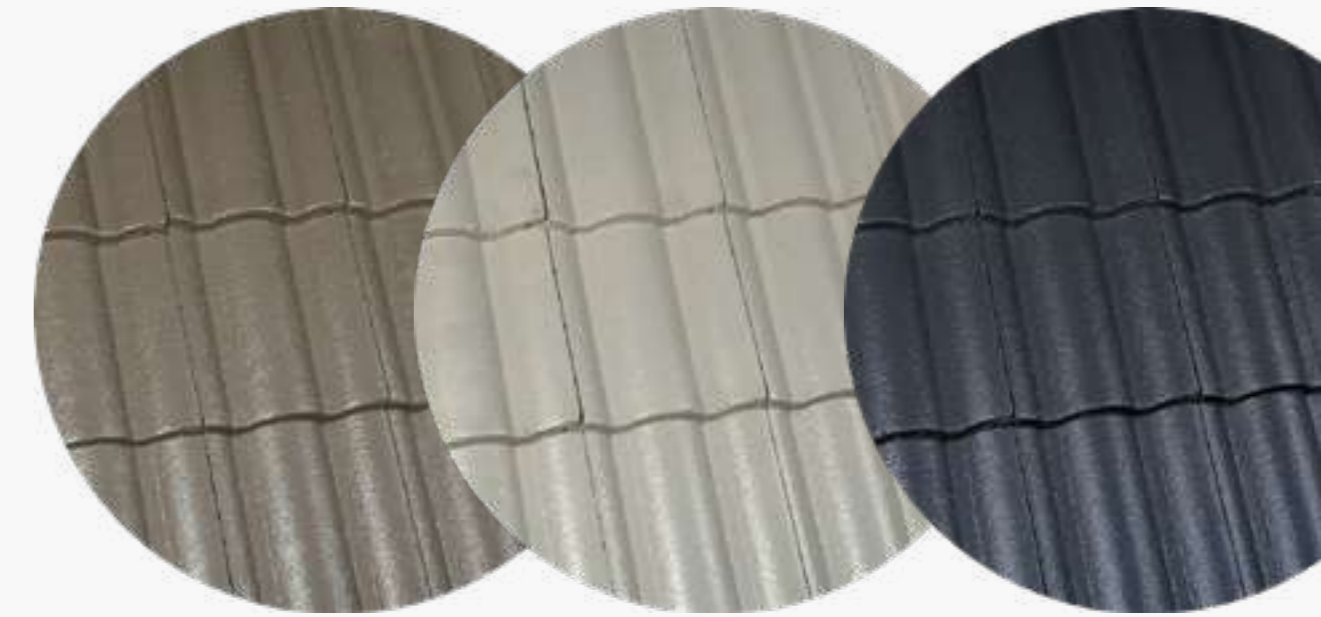

### Elabana Tiles Colour Range



**Sarking** Enhance roof insulation with reflective foil sarking beneath tiles, providing added protection and insulation for your home.

Bricks play an indispensable role as a primary construction material for homes. They offer essential structural support, insulation, and durability, ensuring the strength and longevity of buildings. Additionally, bricks contribute to the visual charm of a home with their wide range of colours and textures. Together, these qualities of bricks combine to establish a secure and pleasant living environment, making them a crucial component in the construction industry.



Images are indicative only

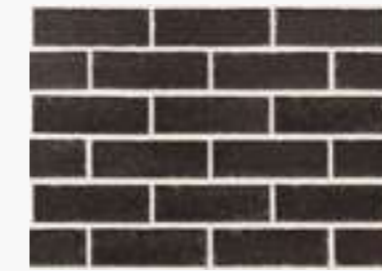

Eclips

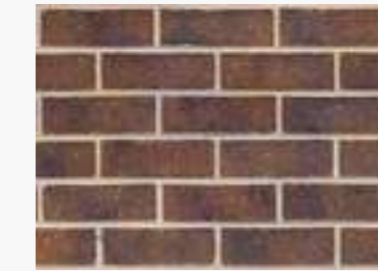

Gibson

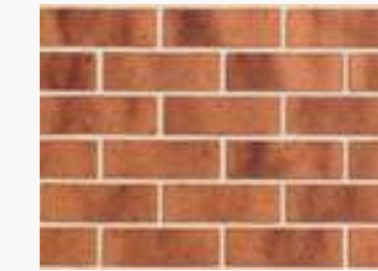

Red Gum



Moon Dust



Stone

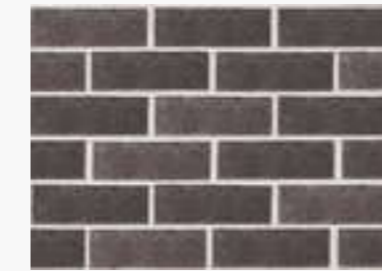

Monsoon



Dark Rum

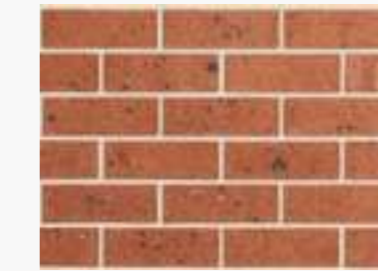

Hampshire



Beach



Silica



Thunder



Gravel

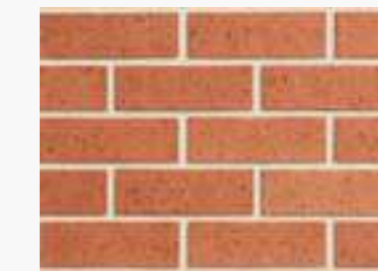

Pilbara



Perisher



Hotham



Zephyr



Surrey



DORSET



Gull Grey



Frost



Whirlwind



Sinai



Kent

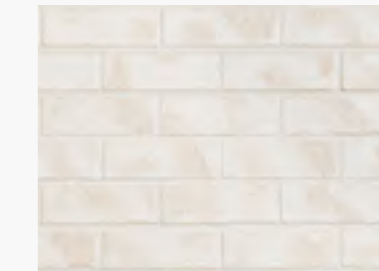

Washed White



Lightning

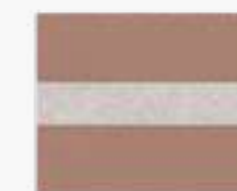

### Mortar Joint

Ironed joints are very effective at repelling rain penetration due to its recessed profile and the tight seal formed by compacted mortar..  
Speak to your sales consultant about additional brick selections and joint types.

Images are indicative only

## Main Entry Door

The main entry door plays a crucial role in a home, ensuring security while leaving a lasting first impression. It sets the tone for the entire house, showcasing the homeowner's unique style and personality. A durable and well-designed door adds value, boosts curb appeal, and enhances energy efficiency, making it an essential element of home design.



XN6 SPM Veneer  
2040X820X40 TRANS



Nex35-spm-translucent



VERVE VER1  
2040X820X40 TRANS



XN7 SPM Veneer  
2040X820X40 TRANS



VER4 Duracote  
2040X820X40 TRANS

Images are indicative only

Speak with our colour consultant for more information.

## Garage Roller Doors

A garage door is a sizeable panel that covers a garage entrance, serving to safeguard the contents and enhance a home's aesthetic. It can be opened manually or via a motorized mechanism, with the primary function of offering secure access to the garage for storing vehicles and other items.

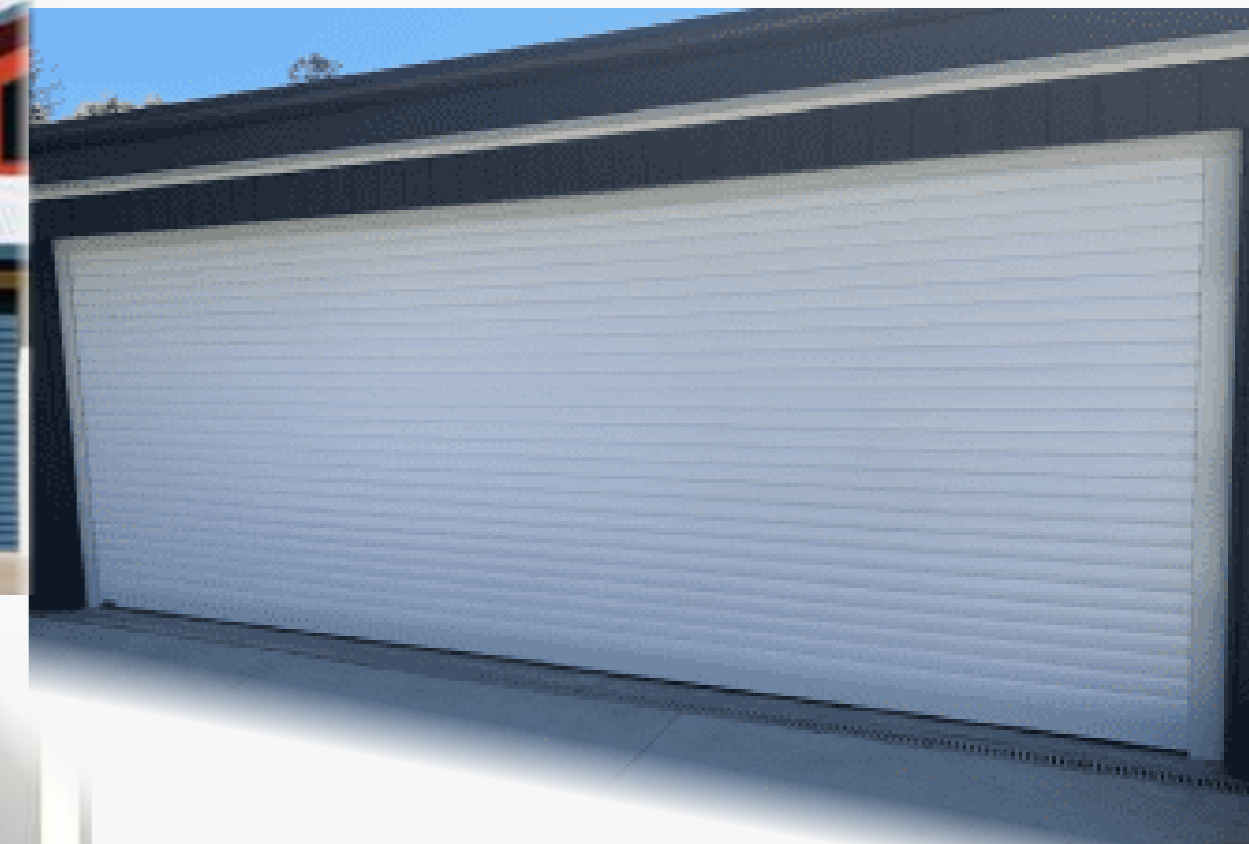

Included in DCH's standard features are a roller garage door with standard height and width as per the plan, which can be customized to your preferred color and style. Additionally, an automatic opener and two remotes are also part of the package

Images are indicative only

Speak with our colour consultant for more information.

To maintain a cohesive aesthetic, make sure the gutter and fascia share the same colour as the roof. However, you also have the option of having the gutter match the roof while the fascia complements a different colour found elsewhere on the house, like the windows or other accents. Another approach is to keep the gutter and fascia in the same colour but in contrast to the roof. When envisioning your ideal home, carefully consider your choices for the roof, walls, textures, and colours to achieve a distinctive and personalized appearance that elevates your home's curb appeal.



## Classic Finish



## Painted Downpipes

Customize your look with painted UPVC 90mm downpipes, available in various colours to perfectly complement your accents.



Choosing windows for your house depends on its architecture, with various sizes and shapes available. It's important to select windows that are suitable for your home. Additionally, windows play a significant role in heat transfer, especially in extreme weather areas. Certain frames and glazing can minimize thermal gains and losses, improving comfort and energy efficiency. Apart from aesthetic and light advantages, windows also enhance security. Prioritizing windows that enhance your home's security is crucial while enjoying their functional and decorative benefits.



Painting in the home adds a touch of personal style and transforms living spaces. With a brushstroke, walls come alive with colour, setting the ambience and reflecting individual tastes. From bold and vibrant hues to soothing pastels, paint can evoke emotions and create a visual masterpiece. It allows homeowners to express their creativity and bring life to dull interiors. Whether it's a feature wall, a fresh coat on cabinets, or a complete room makeover, painting rejuvenates and revitalizes any space. It's a cost-effective way to enhance the overall aesthetic appeal and make a house truly feel like a home.

Taubmans® Ultimate Enamel is a premium, fast drying enamel that uses superior alkyd technology to provide the durability and performance of a traditional oil based enamel, while also being environmentally friendly because it's water based. This innovative technology provides faster dry times and less yellowing than a traditional oil based enamel, while maintaining a smooth finish. Taubmans Ultimate Enamel inhibits mould and mildew, has low VOC, less odour and an easy water clean up. Ultimate Enamel is the ideal choice for a high end professional finish.



The Taubmans® EASYCOAT® interior range has been designed with a family home in mind. With Microban® technology, EASYCOAT protects against the growth of bacteria, mildew and fungus, making it ideal for damp and humid areas like the kitchen, bathroom and laundry. Add a 5 year guarantee\* against mould and it's easy to see why EASYCOAT is the safe family choice.



*Tip: Choose the acrylic based enamel for all your doors, skirting and architraves as it doesn't yellow*

*Complimentary by DESTINY CUSTOM HOMES*



➤ Colourful, long-lasting ventilators boost natural air-flow. Whirlybirds come with matching roof tile hues for a seamless aesthetic.



➤ Coloured Concrete Driveway

➤ Westinghouse Microwave Stainless Steel from the DCH's range.



➤ HPM Battery Operated Wireless Doorbell Chime. from the DCH's range.



➤ Independent quality inspection upon completion

➤ Roof mounted TV antenna



➤ Wide range of ceramic tiles available for front porch, balcony, and alfresco. Tiled alfresco floor with 150mm riser tile to the external edge.





## Exclusions & Disclaimers

*Destiny Custom Homes reserves the rights to vary inclusions and/or products at any time. Should a different brand be substituted it will be replaced with a product of equal or better standard.*

*Any photographs appearing in Destiny Custom Homes brochures, are indicative only and do not constitute an offer of what will be included in any individual home. Please refer to your building contract for the specific design and inclusion details for your new home.*

 12 Wirraga Street Bungaribee NSW 2767

 0405 DCH DCH (324 324), 0405 638 206

 info@dchnsw.com.au

 www.dchnsw.com.au

 Builders licence: 393520C

 ABN 17 659 062 423

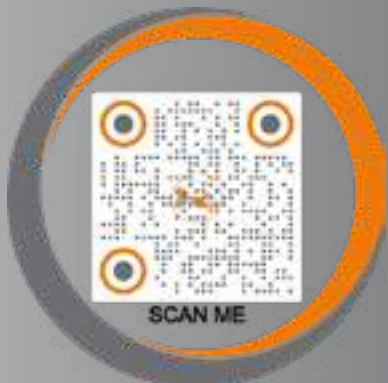

 facebook.com/DCHomes22 instagram.com/

 destinycustomhomes/

 linkedin.com/in/destiny-custom-homes-435463239/

 twitter.com/Destiny\_C\_Homes